

KIT/301-04LB-P4/4*3612LR3-PF28-D



Key Features

NVR301-04LB-P4

- Support Ultra 265/H.265/H.264 video formats
- 4-channel input
- Plug & Play with 4 independent PoE network interfaces
- Third-party IP cameras supported with ONVIF conformance: Profile S, Profile G, Profile T
- Support 1-ch HDMI, 1-ch VGA
- HDMI and VGA simultaneous output
- Up to 2MP resolution recording
- 1 SATA HDD, up to 8 TB
- Support cloud upgrade

IPC3612LR3-PF28-D

- Day/night functionality
- Smart IR, up to 30 m (98 ft) IR distance
- D DNR (Digital Noise Reduction)
- Ultra 265,H.265,H.264,MJPEG
- ROI (Region of Interest)
- ONVIF Conformance

- Wide temperature range: -30°C to 60°C (-22°F to 140°F)
- Wide voltage range of ±25%
- IP67

Specifications

Model	NVR301-04LB-P4
Video/Audio Input	
IP Video Input	4-ch
Network	
Incoming Bandwidth	40Mbps
Outgoing Bandwidth	40Mbps
Remote Users	128
Protocols	P2P, UPnP, NTP, DHCP, PPPoE
Video/Audio Output	
HDMI/VGA Output	HDMI: 1920x1080p /60Hz, 1920x1080p /50Hz, 1600x1200 /60Hz, 1280x1024 /60Hz, 1280x720 /60Hz, 1024x768 /60Hz VGA: 1920x1080p /60Hz, 1920x1080p /50Hz, 1600x1200 /60Hz, 1280x1024 /60Hz, 1280x720 /60Hz, 1024x768 /60Hz
Recording Resolution	1080p/960p/720p/D1/2CIF/CIF
Synchronous Playback	4-ch
Corridor Mode Screen	3/4
Decoding	
Decoding format	Ultra 265/H.265/H.264
Liveview/ Playback	1080p/960p/720p/D1/2CIF/CIF
Capability	2 x 1080p@30, 4 x 720p@30
Hard Disk	
SATA	1 SATA interface
Capacity	up to 8TB for each disk
External Interface	
Network Interface	1 RJ45 10M/100M self-adaptive Ethernet Interface
USB Interface	Rear panel: 2 x USB2.0
PoE	
Interface	4 independent 100 Mbps PoE network interfaces
Max Power	Max 30W for single port
Supported Standard	IEEE 802.3at, IEEE 802.3af
General	
Power Supply	48V~52V DC Power Consumption: ≤5 W(without HDD)
Working Environment	-10°C ~ + 55°C (+14°F ~ +131°F), Humidity ≤ 90% RH(non-condensing)
Dimensions(W×D×H)	205mm × 205mm × 42mm(8.1" × 8.1" × 1.7")

Weight (without HDD)	0.64kg (1.41lb)				
Model	IPC3612LR3-PF28-D				
Sensor	1/2.7", 2megapixel, progressive scan, CMOS				
Lens	2.8mm@F2.0				
DORI Distance	Lens	Detect(m)	Observe(m)	Recognize(m)	Identify(m)
	2.8mm	46.7	18.7	9.3	4.7
Angle of view(H)	86.5°		112.7°		
Angle of View (V)	44.1°		60.1°		
Angle of View (O)	106.4°		146.5°		
Shutter	Auto/Manual, 1/6~1/100000 s				
Adjustment angle	Pan: 0°~360°		Tilt: 0°~90°		Rotate: 0°~360°
Min. Illumination	Colour: 0.02 Lux (F2.0, AGC ON) 0 Lux with IR				
IR Range	Up to 30m (98 ft) IR range				
Day/Night	IR-cut filter with auto switch (ICR)				
S/N	>52dB				
WDR	Supported				
Noise Reduction	2D/3D				
Video					
Max. Resolution	1920×1080				
Video Compression	Ultra 265,H.265,H.264,MJPEG				
Frame Rate	Main Stream:1080P (1920*1080): Max. 25 fps; Sub Stream: 720P (1280*720): Max. 25 fps; Third Stream: CIF (352*288): Max. 25fps				
OSD	Up to 4 OSDs				
Privacy Mask	Up to 8 areas				
ROI	Up to 2 areas				
Motion Detection	Up to 4 areas				
Network					
Protocols	IPv4,IGMP,ICMP,ARP,TCP,UDP,DHCP, RTP,RTSP,RTCP,DNS,DDNS,NTP,FTP,UPnP,HTTP,HTTPS,SMTP,SNMP,SSL				
Compatible Integration	ONVIF(Profile S),API				
Interface					
Network	10/100M Base-TX Ethernet				
General					
Power	12 V DC±25%, PoE (IEEE802.3 af)				
	Power consumption: Max 5.5W				
Dimensions (∅ x H)	∅118x 96 mm (∅4.6" x 3.8")				
Weight	0.2kg (0.44lb)				
Working Environment	-30°C ~ +60°C (-22°F ~ 140°F), Humidity :10%~90% RH(non-condensing)				
Ingress Protection	IP67				

Dimensions

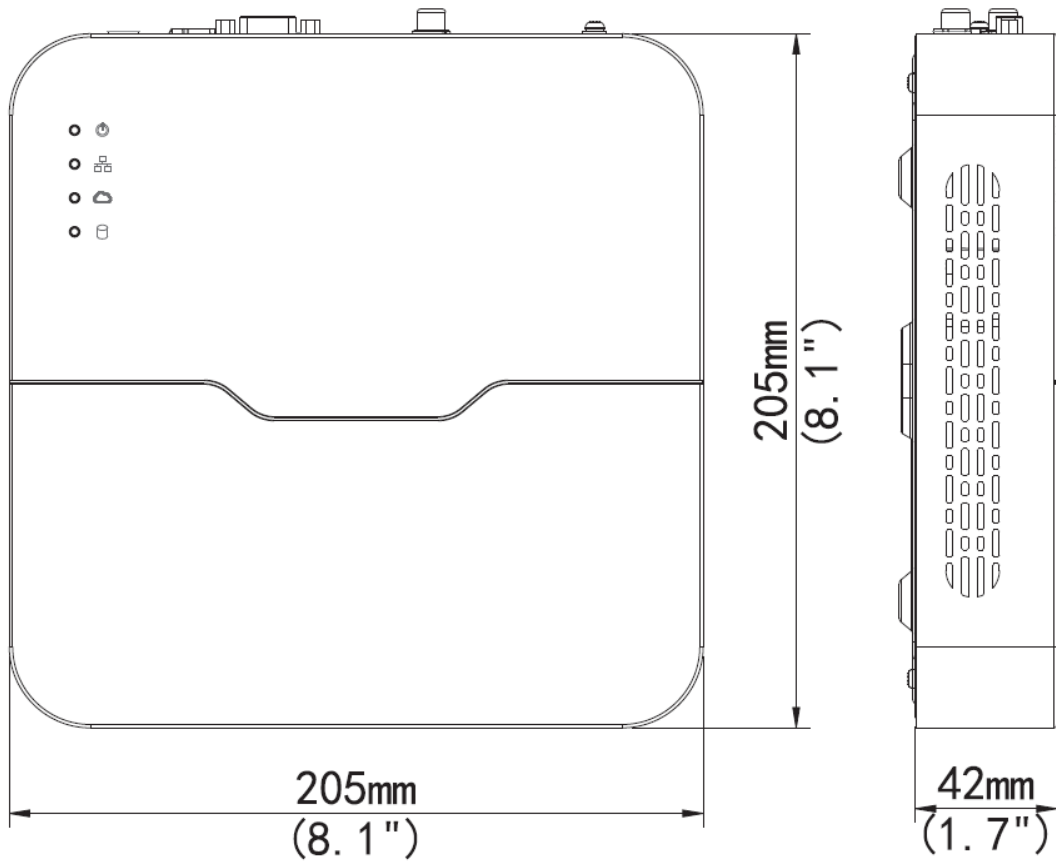

Rear Panel

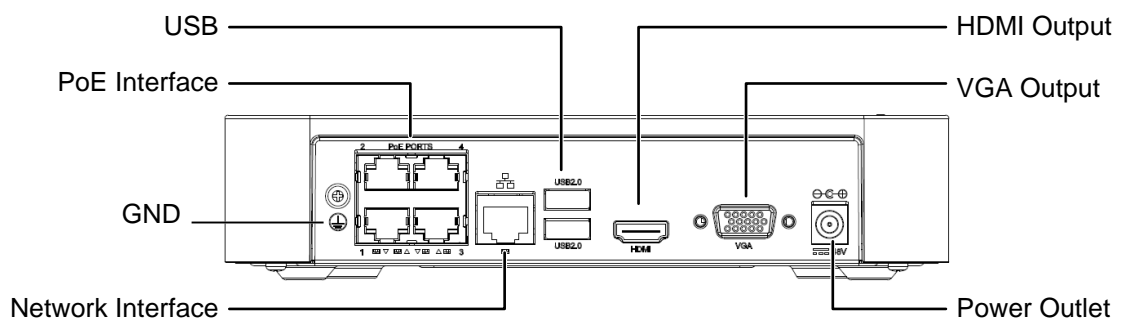

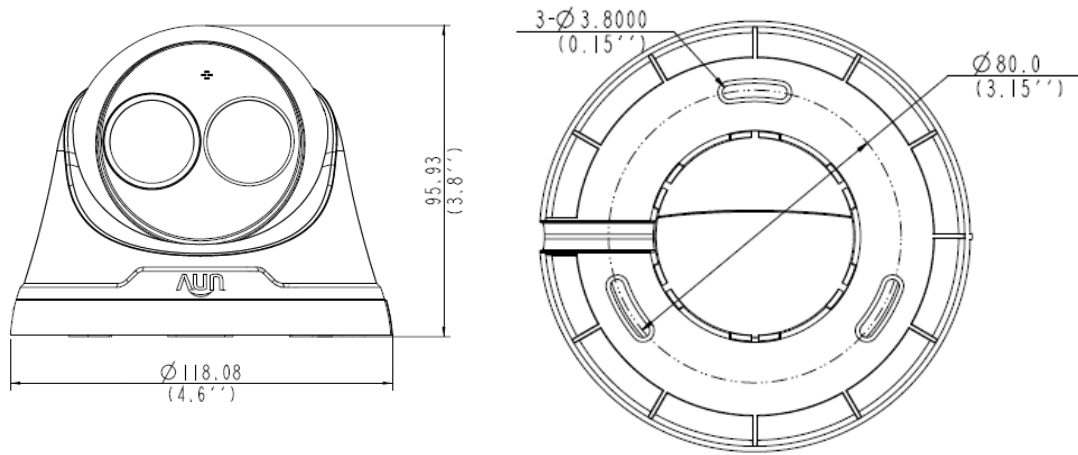

Zhejiang Uniview Technologies Co.,Ltd.

Building No.10, Wanlun Science Park, Jiangling Road 88, Binjiang District, Hangzhou, Zhejiang, China

Email: overseasbusiness@uniview.com; globalsupport@uniview.com

<http://www.uniview.com>

©2018 Zhejiang Uniview Technologies Co.,Ltd. All rights reserved.

*Product specifications and availability are subject to change without notice.