

KIT/301-04LB-W/4*2122SR3-F40W-D



Key Features

NVR301-04LB-W

- Support 2.4GHz , Support two-antenna to strengthen the WiFi signal
- Embedded WiFi Module with high-performance and high stability
- Support CCMP encryption and WPA2-PSK authentication, Support IP cameras with WiFi in access
- Support Ultra 265/H.265/H.264 video formats
- 4-channel input
- Third-party IP cameras supported with ONVIF conformance: Profile S, Profile G, Profile T
- Support 1-ch HDMI, 1-ch VGA
- HDMI and VGA synchronous outputs provided
- Up to 1080p resolution recording
- 1 SATA HDD, Up to 8TB for each HDD
- ANR technology to enhance the storage reliability when the network is disconnected
- Support cloud upgrade

IPC2122SR3-F40W-D

- Day/night functionality
- Smart IR , up to 30 m (98 ft) IR distance
- Optical glass window with higher light transmittance
- IR anti-reflection window to increase the infrared transmittance
- 2D/3D DNR (Digital Noise Reduction)
- Ultra 265,H.265, H.264, MJPEG
- Embedded smart algorithm
- Triple streams
- 9:16 corridor format
- ONVIF Conformance
- Wide temperature range: -30°C ~ +55°C (-22°F ~ 131°F)
- Wide voltage range of ±25%
- IP66

Specifications

Model	NVR301-04LB-W
Video/Audio Input	
IP Video Input	4-ch
Network	
Incoming Bandwidth	40Mbps
Outgoing Bandwidth	40Mbps
Remote Users	128
Protocols	P2P, UPnP, NTP, DHCP, PPPoE
Video/Audio Output	
HDMI/VGA Output	HDMI: 1920x1080p /60Hz, 1920x1080p /50Hz, 1600x1200 /60Hz, 1280x1024 /60Hz, 1280x720 /60Hz, 1024x768 /60Hz VGA: 1920x1080p /60Hz, 1920x1080p /50Hz, 1600x1200 /60Hz, 1280x1024 /60Hz, 1280x720 /60Hz, 1024x768 /60Hz
Recording Resolution	1080p/960p/720p/D1/2CIF/CIF
Audio Output	1-ch, RCA
Synchronous Playback	4-ch
Corridor Mode Screen	3/4
Decoding	
Decoding format	Ultra 265/H.265/H.264
Live view/ Playback	1080p/960p/720p/D1/2CIF/CIF

Capability	4 x 1080P@20, 4 x 720P@30				
Hard Disk					
SATA	1 SATA interface				
Capacity	Up to 8TB for each HDD				
External Interface					
Network Interface	1 RJ45 10M/100M self-adaptive Ethernet Interface				
USB Interface	Rear panel: 2 x USB2.0				
Wi-Fi					
Frequency	2.4GHz				
Transmission Rate	150Mbps				
Wireless Standards	IEEE 802.11b/g/n				
Wireless Range	280m(open environment)				
General					
Power Supply	12V DC Power Consumption: ≤ 9 W(without HDD)				
Working Environment	-10°C ~ +55°C (+14°F ~ +131°F), Humidity ≤ 90% RH(non-condensing)				
Dimensions(W×D×H)	205mm ×228mm ×47mm (8.1" × 9.0"×1.9")				
Weight (without HDD)	≤ 0.98Kg(2.16lb)				
Model	IPC2122SR3-F40W-D				
Sensor	1/2.7", 2.0 megapixel, progressive scan, CMOS				
Lens	4.0mm@F1.8				
DORI Distance	Lens	Detect(m)	Observe(m)	Recognize(m)	Identify(m)
	4mm	60	24	12	6
	6mm	90	36	18	9
Angle of view(H)	86.5°				
Angle of View (V)	44.1°				
Angle of View (O)	106.4°				
Adjustment angle	Pan: 0°~360°		Tilt: 0°~90°		Rotate: 0°~360°
Shutter	Auto/Manual, 1/6~1/100000 s				
Minimum Illumination	Colour: 0.01 Lux (F1.8 AGC ON) 0 Lux with IR on				
Day/Night	IR-cut filter with auto switch (ICR)				
Digital noise reduction	2D/3D DNR				
S/N	>52dB				
IR Range	Up to 30m (98 ft) IR range				
Defog	Digital Defog				
WDR	DWDR				
Video					
Video Compression	Ultra 265, H.265, H.264, MJPEG				
H.264 code profile	Baseline profile, Main Profile, High Profile				
Frame Rate	Main Stream:2MP (1920×1080): Max. 20 fps; Sub Stream: 2MP (1920×1080): Max. 20 fps; Third Stream:D1 (720×576): Max. 20 fps				
9:16 Corridor Mode	Supported				
HLC	Supported				

BLC	Supported
OSD	Up to 4 OSDs
Privacy Mask	Up to 4 areas
ROI	Up to 8 areas
Motion Detection	Up to 4 areas
Storage	
Edge Storage	Micro SD, up to 128 GB
Network Storage	ANR
Network	
Protocols	IPv4, IGMP, ICMP, ARP, TCP, UDP, DHCP, PPPoE, RTP, RTSP, RTCP, DNS, DDNS, NTP, FTP, UPnP, HTTP, HTTPS, SMTP,
Compatible Integration	ONVIF(Profile S, Profile G), API
Wi-Fi	
Wireless Standards	IEEE802.11b/g/n
Frequency Range	2.4 GHz ~ 2.4835 GHz
Channel Bandwidth	20 MHz Support
Modulation Mode	802.11b: CCK, QPSK, BPSK 802.11g/n: OFDM
Security	64/128-bit WEP, WPA/WPA2, WPA-PSK/WPA2-PSK, WPS
Transmit Power	802.11b: 17±1.5dBm @11Mbps 802.11g: 14±1.5dBm @ 54Mbps 802.11n: 12.5±1.5dBm
Receive Sensitivity	802.11b: -90dBm @ 11Mbps (Typical) 802.11g: -75dBm @ 54Mbps (Typical) 802.11n: -74dBm (Typical)
Transmission Rate	802.11b: 11Mbps 802.11g: 54Mbps 802.11n: up to 150Mbps
Interface	
Network	1 RJ45 10M/100M Base-TX Ethernet
General	
Power	12 V DC(+/-25%)
	Power consumption: Max 6.4 W
Dimensions (L × W × H)	157.3 × 63 × 62.4 mm (6.2" × 2.5" × 2.5")
Weight	0.45 kg (0.99 lb)
Working Environment	-30°C ~ +55°C (-22°F ~ 131°F), Humidity ≤ 95% RH(non-condensing)
Ingress Protection	IP66
Reset Button	Supported

Dimensions

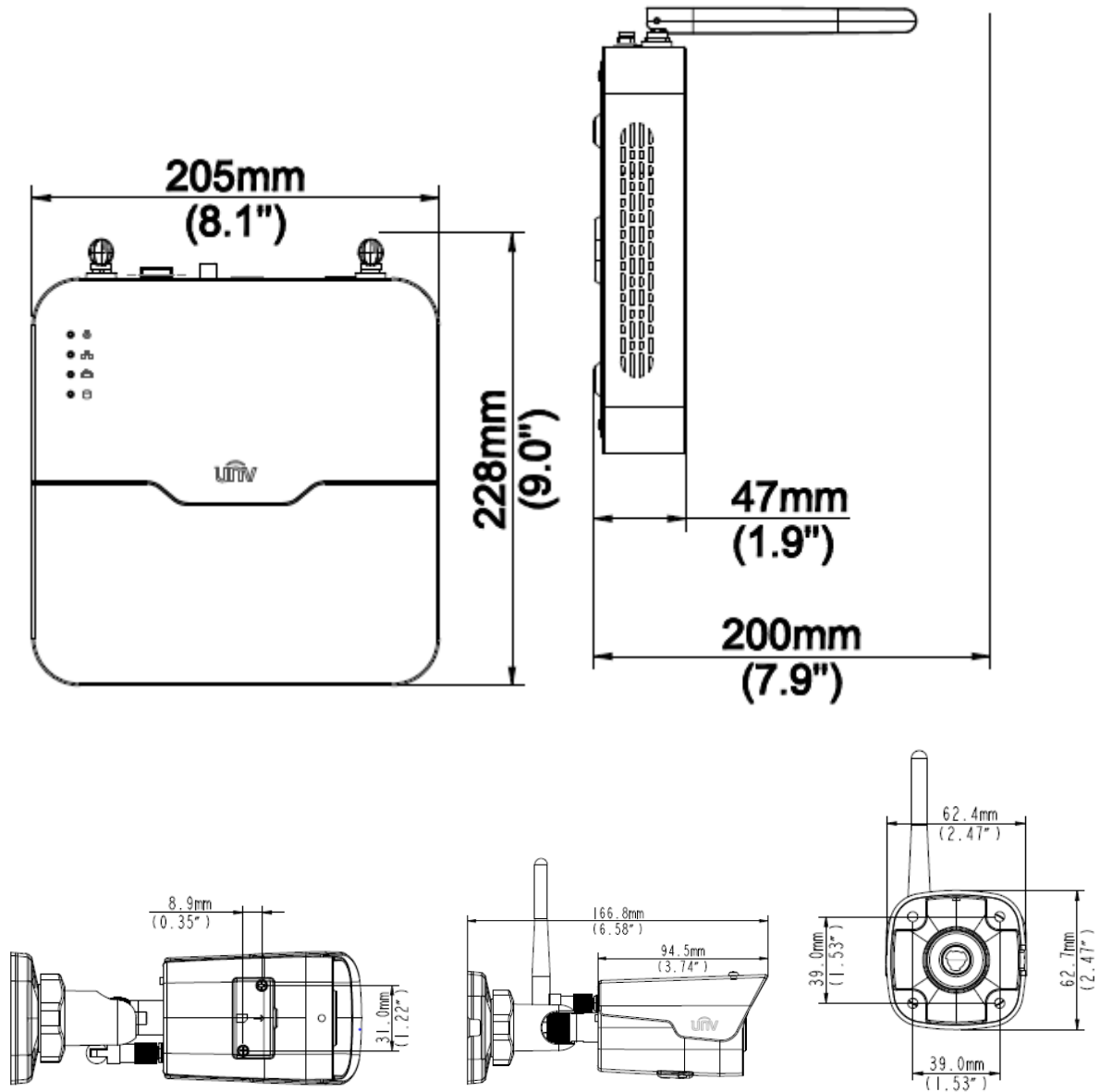

Rear Panel

Zhejiang Uniview Technologies Co., Ltd.

Building No.10, Wanlun Science Park, Jiangling Road 88, Binjiang District, Hangzhou, Zhejiang, China

Email: overseasbusiness@uniview.com; globalsupport@uniview.com

<http://www.uniview.com>

©2018 Zhejiang Uniview Technologies Co.,Ltd. All rights reserved.

*Product specifications and availability are subject to change without notice.