

19" DYNAmic Free Standing Cabinets
F A M I L Y

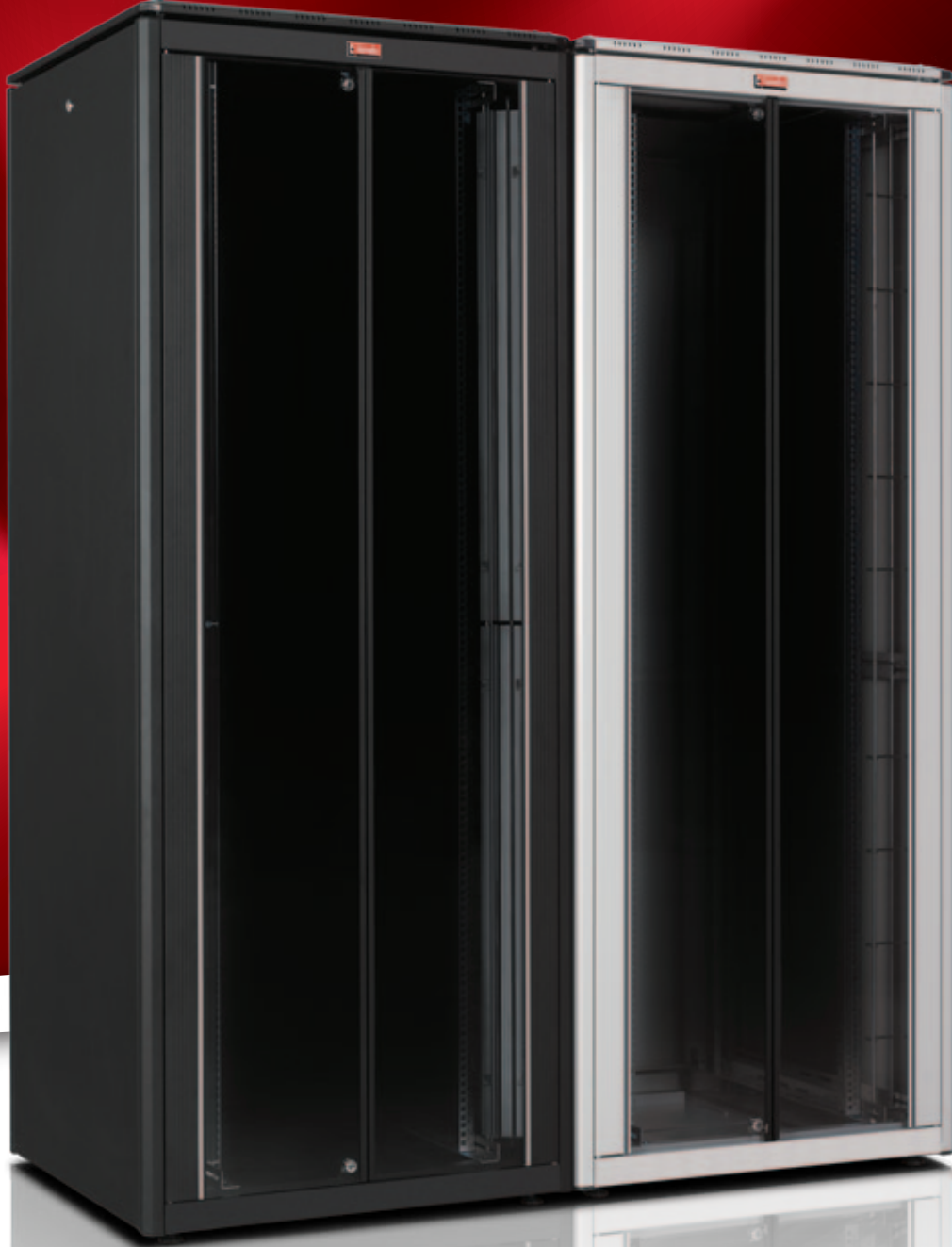

F A M I L Y

W=600mm DYNAMIC Series Free Standing Cabinets

DYNAMIC series Networking / Servering Enclosures, provide maximum optimization resulted to an optimum performance in between quality and added value.

While product gives maximum performance on cabling and networking infrastructure, in parallel provides a very respective economy compared to its quality which is based on high technologic fully automated industry.

The 600 series is available in 10 heights from 12U through to 45U, and in certain sizes a choice of depth is also available including 600, 800 and 1000mm options. Each cabinet is supplied as standard with a glass front door, steel rear door and lift off steel side panels, all of which are lockable. The 800 wide series are starting from 22 to 45U size

The wide product height portfolio meets any U requirement in infrastructure needs.

DYNAMIC series have a professional technical but aesthetic look with decorative Aluminium Extruded Housing on the front door; the product range attracts the attention with the mostly environmentally fit and selected color of RAL 9005 Black, and RAL 7035 Light Grey, with fine wrinkle soft touch paint.

The product range allows with 1000mm depth versions, usage in private / low density server and storage applications.

Completely standard and stocked product portfolio, being delivered a single piece assembled product, as shipping configuration the adjustable feet group is included.

DYNAMIC Series product range with optimal panel mounting size, and a variety range of accessories enclose the whole expectation of users.



CONSTRUCTION DETAILS:

Main Profile- Framework- Top/Bottom Cases and Pagoda Style Roof:

Multi Folded Automated Bending technology applied corner profile system, provides a heavy duty structure results to high load capacity of: 600 kgs.

Monoblock multi folded top and bottom cases, tightly fixed to the framework with fixing hardware, fully modular system generated.

Top case has a ready Forced Ventilation (Fan Module) integration housing.

Fan Module installation is from roof, where the Pagoda Style Roof to be removed first. The advantage of this system is, once the Fan Unit needs maintenance or replacement and while the cabinet is carrying integrated active and passive networking devices, than subject to remove some of them to replace the Fan Module Unit. Lande Cabinet Fan Module Unit access is from roof where no interference with the already installed components inside cabinets.

Bottom case integrated with wide cable entry point provides maximum versatility. The rubber edged sliding mechanism on the cable entry point at bottom with $w=350\text{mm} \times d=250\text{mm}$ allows large cabling infrastructure applications. On rubber edged sliding mechanism max cable entry opening is $w=350\text{mm} \times d=150\text{mm}$. After inserting the cables, the rubber edged mechanism holds and fixes the cables in parallel preventing the cabinet from dust entry.

Pagoda Style Roof located 10mm above the Top Case, allows passive air ventilation via convection, in case of integration with a Fan Unit for forced ventilation intend, the Pagoda style roof allows easy discharge of hot air from cabinet while preventing the cabinet from dripping water or falling dust. Pagoda Style Roof corners and Main Profile junction are closed with Anthracite Grey and Black color complementary PVC application for aesthetical appearance.

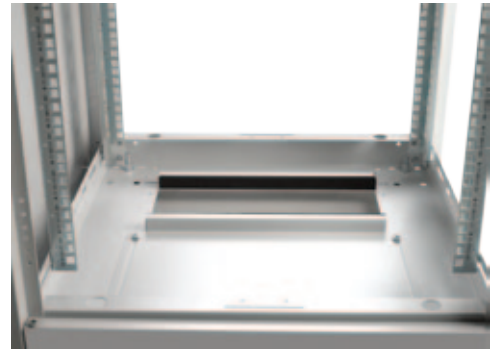
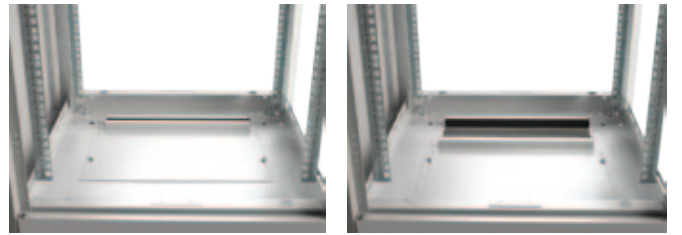

CONSTRUCTION DETAILS:

Access to enclosure:

Front door is integrated with decorative 2,5mm thickness aluminium extruded frames, full length smoked, shatterproof, antistatic, 4,0mm thickness glass with single point locking handled lock.

Front door Aluminium extruded frame allows, decorative PVC Stripes charming the attraction, Anthracite Grey for RAL 7035 Light Grey Cabinets and Light Grey for RAL 9005 Black cabinets

Front door opening direction is set right to left, but reversible to left to right at site with removing the hinge system. Hinge System is spring loaded easy operating version, which allows you to remove the whole front door from cabinet in seconds.

Alternative doors and panels are available for customer selection.

Side Panels are lockable and removable with barrel style lock, Multifolded bending technology with 8 fold bending provides the rigidity. Easy mechanical locking of panel to main frame with snap capture system allows easy attachment of panels and easy removal in seconds while installation in process.

Rear Panels are lockable and removable with barrel style lock, Multifolded bending technology with 8 fold bending provides the rigidity. For best optimized cost conduction to customers, the rear panel designed and created with same mechanical concept and sizes of the side panels. In case of more mechanical and functional needs as a hinged rear door, there are various design and functionality on the created selection charts, please find them for each product size at related pages.

19" rails of Lande DYNAMIC Series Free Standing cabinets are with automated silk-screen U numbering, depends on size 1U to 45U, same from top to bottom or bottom to top results to same U height selection. No matter from where you have started counting. 19" rails are 4 fold bending surfaces, 1,5mm thickness provides the high load capacities. The 19" rails are made of steel with 8-12 micron zinc plating for corrosion resistance. 19" rails are adjustable in depth. For easy adjustment purpose, no need to detach the screws, just ease the screws and slide them in the channels on the top/bottom chassis bends.

Side Horizontal Support Bar in depth; up to 26U the 19" rails are fixed to just top and bottom case. Higher than 26U the cabinets are integrated with 1 set (left/right), 1,5mm thickness Z type made of Steel + 8-12 micron zinc plated side horizontal support bar.

All design features provide 4 way access to your enclosure and equipments, easy to reach to enclosure and equipments for all infrastructure installations and maintenance needs.



Width=600mm
Depth=600mm

Load Capacity: 600 kgs.

Standard Heights:

10 different U heights: 12U, 16U,
20U, 22U, 26U, 32U, 36U, 39U,
42U, 45U

Standards, and Compliances:



ISO 9001:2008

Quality Management System

EN 61587 -1:2012
Mechanical Structures for
Electronic Equipment

IEC 297-1, 19" mounting
IEC 297-2 Overall cabinet dimensions



CE conform to
EN 60950-1:2006
Information Technology
Equipment – Safety – Part-1-
General Requirements



Environment Friendly;
*Environmental awareness
*RoHS compliancy
*% 100 Recyclable
Material



Standard Colors:



RAL 9005 Black

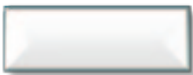

RAL 7035 Light Grey

DYNAMIC series Networking Enclosures, with 19" w:600mm
and d:600mm physical sizes, with max internal usable depth
and 10 different height, gives a wide selection chart for users.

*** Please see door options at the end of each product size.



DETAILS ON
EXPLODED VIEW

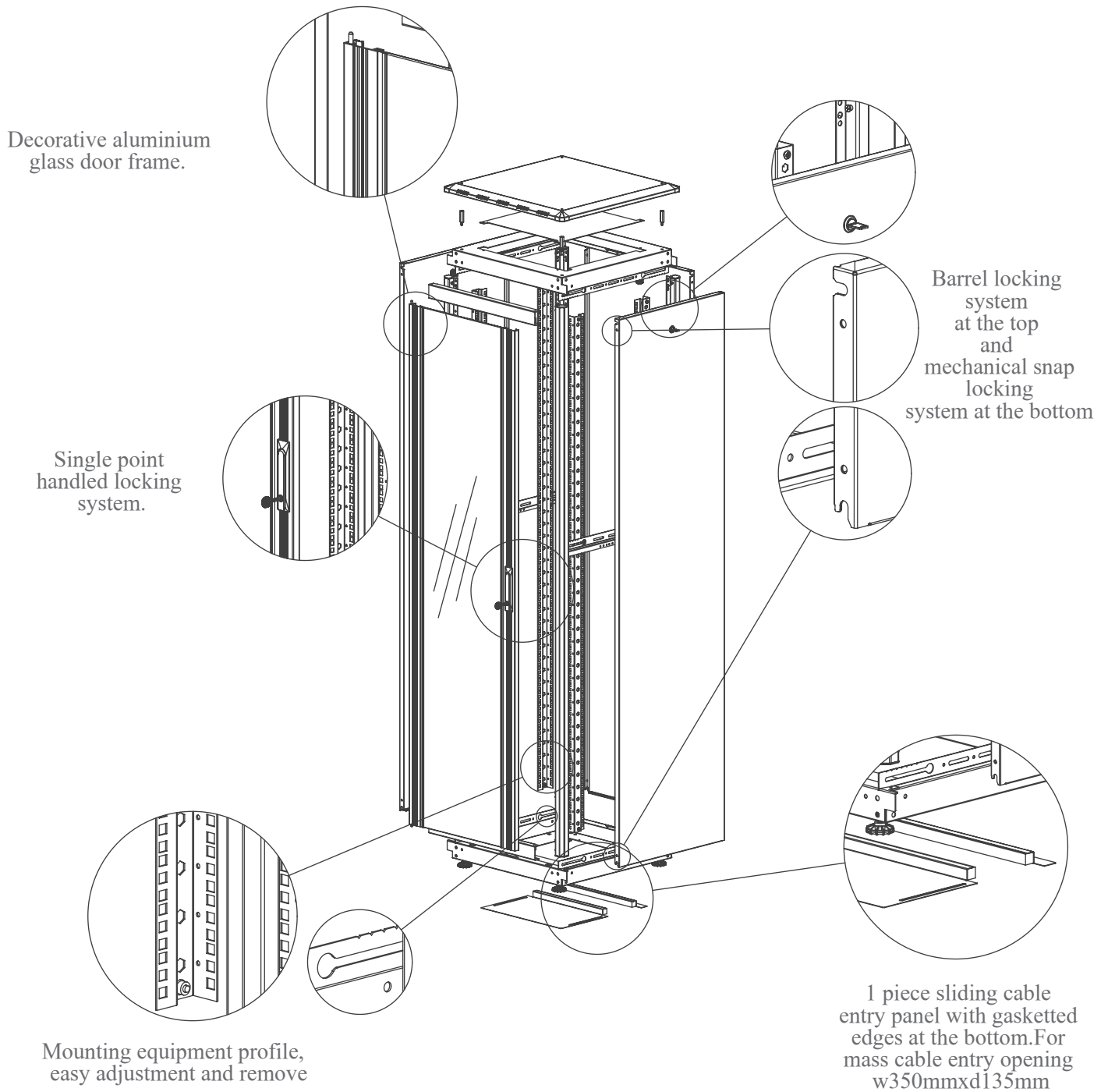

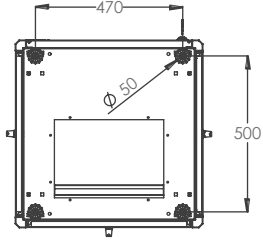

BOTTOM VIEW

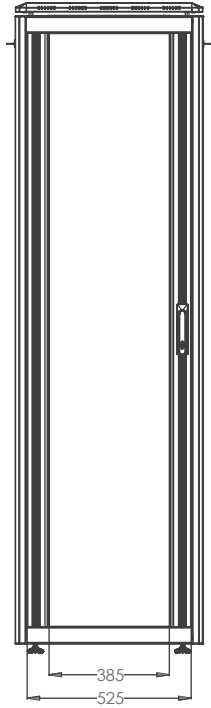

FRONT VIEW

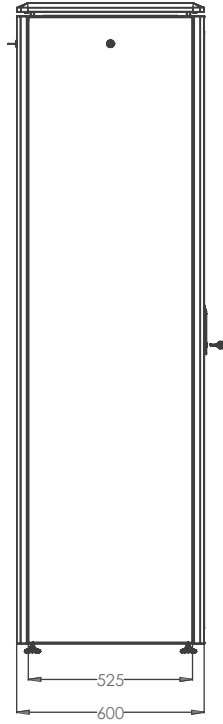

SIDE VIEW

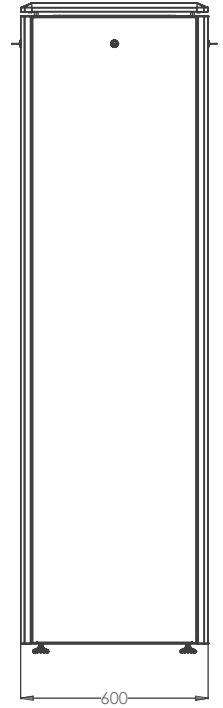

REAR VIEW

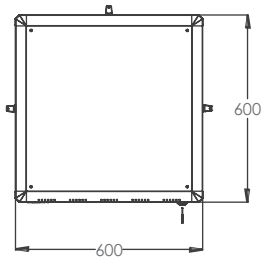

TOP VIEW

CONSTRUCTION
DRAWING

CONSTRUCTION
DRAWING

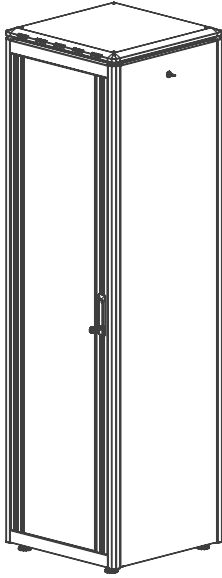

ISOMETRIC VIEW

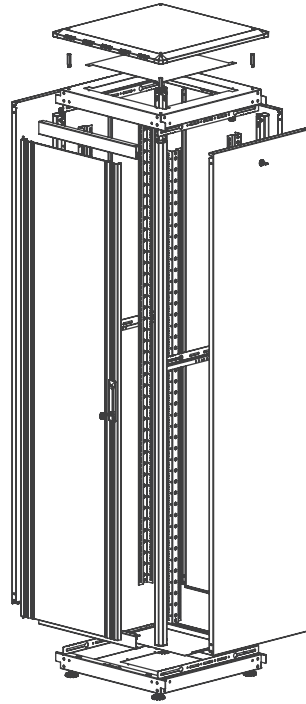

EXPLODED VIEW

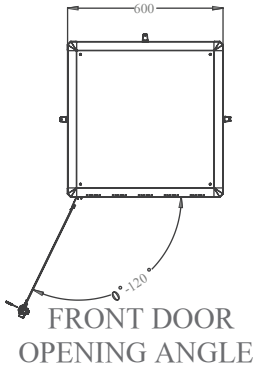

FRONT DOOR
OPENING ANGLE

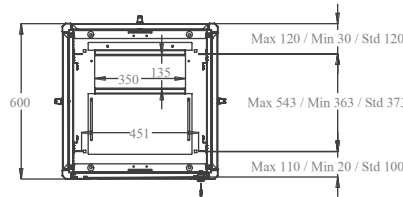

MAX/STD/MIN
EQUIPMENT
MOUNTING
DISTANCE

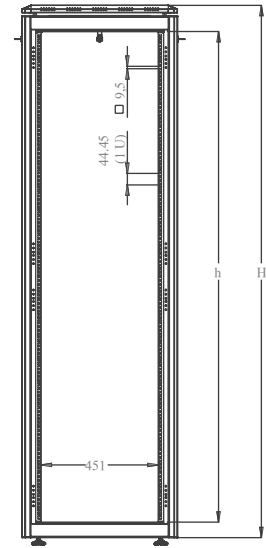

DIMENSIONS
IN
WIDTH AND HEIGHT

DYNAMIC Series Free Standing 19" Cabinets W=600mm D=600mm

ROOT Product Number ***	Product Description	Size WxDxH mm	h size in U	h in mm	*H mm, overall without feet and/or castor	Width Overall mm	Width Rail to Rail mm	Depth Overall mm	**Depth Shipping Conf. Rail to Rail mm	QTY IN PACKAGE	PACKING DIMENSIONS WxDxH mm	Standard NET Weight of product kgs	Gross Weight of Product kgs	QTY IN PALLETTE	PALLETTE DIMENSIONS WxDxH mm	Palette Weight kgs
LN-FS12U6060-CC-111	12U 19" Free Standing Cabinet W=600mm D=600mm	600x600x720	12U	533	720	600	19"	600	370	1	680x680x850	35,7	42,9	2	680x680x1700	85,8
LN-FS16U6060-CC-111	16U 19" Free Standing Cabinet W=600mm D=600mm	600x600x898	16U	711	898	600	19"	600	370	1	680x680x1020	40,9	48,5	2	680x680x2076	97
LN-FS20U6060-CC-111	20U 19" Free Standing Cabinet W=600mm D=600mm	600x600x1076	20U	889	1076	600	19"	600	370	1	680x680x1216	45,2	53,2	2	680x680x2432	106,4
LN-FS22U6060-CC-111	22U 19" Free Standing Cabinet W=600mm D=600mm	600x600x1164	22U	978	1164	600	19"	600	370	1	680x680x1305	47,9	56,1	2	680x680x2608	112,2
LN-FS26U6060-CC-111	26U 19" Free Standing Cabinet W=600mm D=600mm	600x600x1342	26U	1155	1342	600	19"	600	370	1	680x680x1482	52,7	61,3	1	680x680x1482	61,3
LN-FS32U6060-CC-111	32U 19" Free Standing Cabinet W=600mm D=600mm	600x600x1609	32U	1422	1609	600	19"	600	370	1	680x680x1749	60,9	70	1	680x680x1749	70
LN-FS36U6060-CC-111	36U 19" Free Standing Cabinet W=600mm D=600mm	600x600x1787	36U	1600	1787	600	19"	600	370	1	680x680x1927	66,3	75,5	1	680x680x1927	75,9
LN-FS39U6060-CC-111	39U 19" Free Standing Cabinet W=600mm D=600mm	600x600x1920	39U	1733	1923	600	19"	600	370	1	680x680x2063	69,6	79,7	1	680x680x2063	79,5
LN-FS42U6060-CC-111	42U 19" Free Standing Cabinet W=600mm D=600mm	600x600x2053	42U	1867	2053	600	19"	600	370	1	680x680x2193	73,7	83,9	1	680x680x2193	83,9
LN-FS45U6060-CC-111	45U 19" Free Standing Cabinet W=600mm D=600mm	600x600x2187	45U	2000	2187	600	19"	600	370	1	680x680x2327	77,3	87,8	1	680x680x2327	87,8

* Please add 30mm to H mm once used with Leveling Feet, add 80mm to H mm once used with castor set.

** See min and max Adjustable depth variations on drawings.

***CC= LG for Light Grey RAL 7035 & BL for Black RAL 9005 for customers to define while ordering, for "111" selection please see the door options.



DOOR
OPTIONS

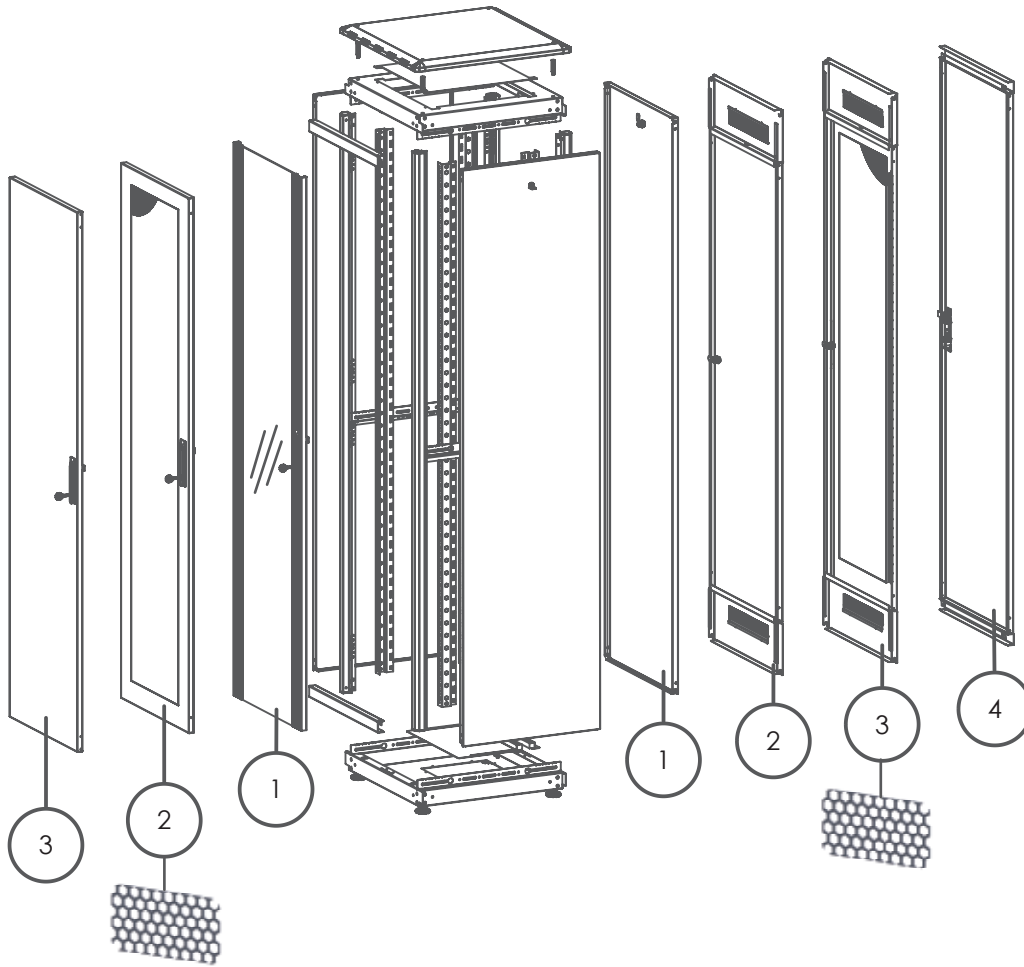

DYNAMIC Free Standing Cabinet W=600mm D=600mm
All Heights FRONT DOOR Options

- 0 Without front Door
- 1 Single Opening, Flat Shape, Side Framed Glass Front Door, Single Point Handled Locking.
- 2 Single Opening, Flat Shape, Complete Framed %63 perforated, Solid Metal Front Door, Single Point Handled Locking
- 3 Single Opening, Flat Shape, Complete Solid Metal Front Door, Single Point Handled Locking

DYNAMIC Free Standing Cabinet W=600mm D=600mm
All Heights REAR DOOR Options

- 0 Without Rear Door
- 1 Solid Metal Panel, Snap locking and Barrel Lock, Single Point Locking
- 2 Single Opening, Flat Shaped, Solid Metal Rear Door, Single Point Barrel Locking, Hinged, Top/bottom Cable entry, and Top/Bottom Metal Bracket Set
- 3 Single Opening, Flat Shape, Complete Framed %63 perforated, Solid Metal Rear Door, Single Point Handled Locking, Top/Bottom Metal Bracket Set.
- 4 Single Opening, Flat Shape, Complete Solid Metal Rear, Single Point Handled Locking, Top/Bottom Metal Bracket Set.

DYNAMIC Free Standing Cabinet
W=600mm D=600mm
All Heights SIDE PANEL Options

- 0 No Side Panel On product
- 1 Two Side Panels, left / right included in shipping configuration
- 2 One Side Panel Only on Left Side
- 3 One Side Panel Only on Right Side

LN-AA

XXU

WW

DD

CC

LN Corporate codification beginning letters mentioning Lande in Short Format as LN

AA Family Group of Enclosure; FS for Free Standing cabinets, WM for Wall Mounting Cabinets, SH for Small office Home office Range, SR for Server enclosure Range, SL for Slim series, RS for Home series wall cabinets

XX Numeric Character defining the height of enclosures, depending on model differences between 12 to 45 to be selected from price list, website or catalogue

U U Height Alfanumeric Notation, concrete (non editable- fixed character)

WW The First 2 digits of the width info, 60 for W=600mm, 80 for W=800mm, 54 for W=540mm, 30 for W=300mm Soho 10" enclosure

DD The First 2 digits of the depth info, 45 for D=450mm, 40 for D=400mm, 60 for D=600mm, 80 for D=800mm, 10 for D=1000mm cabinets

CC Color Code, LG for Light Grey RAL 7035, BL for Black RAL 9005

000

0 Front Door Variation number, numeric character 1 to 9 / 0 means no front door, standard front door defined in Lande System as option 1., Please select other variations if needed from above door selection drawing. Unless defined option 1 should be delivered

0 Rear Door Variation number, numeric character 1 to 9 / 0 means no rear door, standard rear door defined in Lande System as option 1., Please select other variations if needed from above door selection drawing. Unless defined option 1 should be delivered

0 Side Panel/Door Variation number, numeric character 1 to 9 / 0 means no side panel on product, standard side panel/door defined in Lande System as option 1. Unless defined option 1 should be delivered

