



S series **SD9366-EH-v2** Speed Dome Network Camera

1080p 60fps • 30x Zoom • WDR Pro • 250M IR •
Smart IR II • IP66 • IK10 • NEMA 4X • -50°C ~ 55°C • Wiper

The SD9366-EH-v2 is the latest professional IR speed dome camera with wiper from VIVOTEK, specifically designed to enhance low light surveillance in large coverage areas. Equipped with 250M IR illuminators and a 30x optical zoom lens, the SD9366-EH-v2 provides a superb low light image in the most challenging situations. The camera also adopts VIVOTEK's Smart IR II technology, Vari-Angle IR. VIVOTEK's Vari-Angle IR provides smooth vari-angle adjustment of the IR illuminators, allowing broad coverage FOV and highly uniform IR intensity while avoiding hot-spots traditionally associated with IR illumination.

The SD9366-EH-v2 is the PTZ surveillance camera with IR Illumination to utilize H.265 compression technology. When combined with VIVOTEK's Smart Stream II technology users can obtain bandwidth savings of up to 80%* compared to traditional

H.264. By combining 1080p full HD resolution with H.265, IR illuminators, Vari-Angle IR, WDR, and 30x optical zoom, the SD9366-EH-v2 is able to capture fine details at top-notch quality, 24 hours a day, 7 days a week.

VIVOTEK further strengthened the camera performance with an IP66- and NEMA 4X-rated housing to protect the camera against rain, dust, and corrosion. The SD9366-EH-v2 has a wide operating temperature range from -50°C to 55°C, ensuring continuous operation under the most extreme weather conditions and hazardous environments. This makes the SD9366-EH-v2 ideally suited to monitor wide open spaces such as ports, highways, cities, and parking lots where high-level precision is required.

* Depending on scene.

Key Features

- H.265 Compression technology
- 1080P Full HD CMOS Sensor
- 60 fps @ 1080p Full HD
- 30x Zoom Lens
- 250M IR with Smart IR II (Vari-Angle IR)
- 360° Continuous Pan and 220° Tilt
- Removable IR-cut Filter for Day & Night Function
- WDR Pro for Unparalleled Visibility in High Contrast Environments
- Weather-proof IP66-rated, Vandal-proof IK10 and NEMA 4X-rated Housing
- -50°C ~ 55°C Wide Temperature Range for Extreme Weather Conditions
- EIS (Electronic Image Stabilization) to Control Image Stability
- Easy Cleaning with Built-in Wiper



Without Smart IR II



With Smart IR II

Technical Specifications

Model	SD9366-EH-v2
System Information	
CPU	Multimedia SoC (System-on-Chip)
Flash	128MB
RAM	512MB
Camera Features	
Image Sensor	1/2.8" Progressive CMOS
Max. Resolution	1920x1080 (2MP)
Lens Type	30x Optical Zoom, Auto Focus
Focal Length	f = 4.3 ~ 129 mm (30x zoom)
Aperture	F1.6 ~ F4.7
Iris Type	DC-iris
Field of View	2.3° ~ 64° (Horizontal) 1.3° ~ 36° (Vertical) 2.6° ~ 73° (Diagonal)
Shutter Time	1 sec. to 10,000 sec.
WDR Technology	WDR Pro
Day/Night	Yes
Removable IR-cut Filter	Yes
Minimum Illumination	0.195 Lux @ F1.6 (Color) 0.01 Lux @ F1.6 (B/W) 0 Lux with IR illumination on
Pan Speed	0.1° ~ 300° / sec.
Pan Range	360° endless
Tilt Speed	0.1° ~ 300° / sec.
Tilt Range	220° (-110° ~ +110°)
Preset Locations	256 preset locations 128 presets per tour
Pan/Tilt/Zoom Functionalities	48x digital zoom (4x on IE plug-in, 12x built-in), Auto pan mode, Auto patrol mode
IR Illuminators	Built-in IR Illuminators up to 250 meters with Smart IR II, IR LED*2
On-board Storage	Slot type: MicroSD/SDHC/SDXC card slot Seamless Recording
Video	
Compression	H265, H264, MJPEG
Maximum Frame Rate	H.265 & H.264: 60 fps @ 1920x1080 MJPEG: 30 fps @ 1920x1080
Maximum Streams	4 simultaneous streams
S/N Ratio	66 dB
Dynamic Range	130 dB
Video Streaming	Adjustable resolution, quality and constant bit rate control, Smart Stream II
Image Settings	Time stamp, text overlay, flip and mirror, configurable brightness/contrast/saturation/sharpness, white balance, exposure control, gain, backlight compensation, privacy masks (Up to 24), scheduled profile settings, defog, 3DNR, EIS, HLC
Audio	
Audio Capability	Two-way Audio (full duplex)
Compression	G.711, G.726
Interface	External microphone input External line output
Network	
Users	Live viewing for up to 10 clients
Protocols	802.1X, ARP, CIFS/SMB, CoS, DDNS, DHCP, DNS, FTP, HTTP, HTTPS, ICMP, IGMP, IPv4, IPv6, NTCIP, NTP, PPPoE, QoS, RTSP/RTP/RTCP, SMTP, SNMP, SSL, TCP/IP, TLS, UDP, UPnP
Interface	10 Base-T/100 Base-TX Ethernet (RJ-45) *It is highly recommended to use standard CAT5e & CAT6 cables which are compliant with the 3P/ETL standard.
ONVIF	Supported, specification available at www.onvif.org
Intelligent Video	
Video Motion Detection	Five-window video motion detection
Auto-Tracking	Auto-tracking on moving object
VADP Package	Genetec package, Amazon Kinesis Video Streams
Alarm and Event	
Alarm Triggers	Motion detection, manual trigger, digital input, periodical trigger, system boot, recording notification, audio detection, SD card life expectancy
Alarm Events	Event notification via digital output, email, HTTP, FTP, NAS server, SD card File upload via email, HTTP, FTP, NAS server, SD card
General	
Connectors	RJ-45 cable connector for Network 10/100Mbps PoE connection*1 Audio input*1 Audio output*1 AC/DC 24V power input*1 Digital input*4 Digital output*2 RS-485 for PTZ control (PelcoD protocol, Baud rate 2400)*1
LED Indicator	System power and status indicator
Power Input	PoH/PoE (95W) AC/DC 24V
Power Consumption	PoH/PoE (95W): Max. 70 W (Heater on, IR on) Max. 51 W (Heater off, IR on) AC/DC 24V: Max. 63 W (Heater on, IR on) Max. 45 W (Heater off, IR on)
Dimensions	237 x 364 mm
Weight	7.1 kg (with bracket) 5.7 kg (without bracket)
Casing	IP66, IK10, NEMA 4X
Safety Certifications	CE, FCC Class A, VCCI, C-Tick, UL

Technical Specifications

Operating Temperature	Starting Temperature: -40°C ~ 55°C (-40°F ~ 131°F) Working Temperature: -40°C ~ 55°C (-40°F ~ 131°F), DC 24V power input -50°C ~ 55°C (-58°F ~ 131°F), AC 24V/PoH (95W) power input *Wiper is functional at 10°C ~ 55°C (50°F ~ 131°F)
Humidity	98%
Warranty	36 months
System Requirements	
Operating System	Microsoft Windows 8/7 Mac 10.12 (Chrome only)
Web Browser	Chrome 58.0 or above Internet Explorer 10/11
Other Players	VLC: 1.1.11 or above QuickTime: 7 or above
Included Accessories	







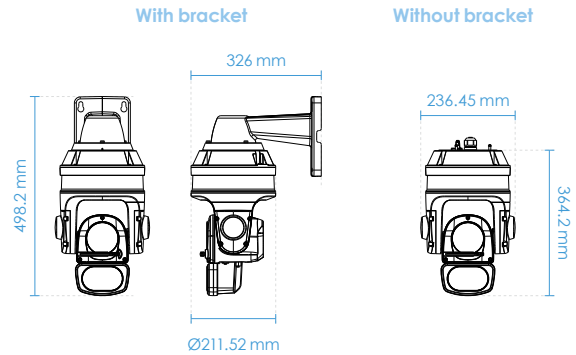











Others

Wall mount bracket, I/O cable, screws, waterproof connectors, terminal blocks, quick installation guide, warranty card, alignment sticker, ground wire, T25 star driver, desiccant bags

Dimensions



Compatible Accessories

Mounting Kits			Others		
 AM-220 Wall Mount Bracket (standard package)	 AM-529 Mounting Adapter	 AE-301 Water Tank, 24VAC/DC, 0°C ~ 60°C	 AJ-001 USB Joystick	 AJ-002 USB Joystick	 AO-007 I/O Combo Cable
Cabinet					
 AT-CAS-001 Cabinet for Speed Dome	 AT-CAB-002 Cabinet for HLG Power Supply	 AT-SUN-002 Sunshield	 AT-SWH-000 Power Safety Kit	➔	
PoE Kit/Power Adapter					
24VAC			24VDC		
 AA-351 Outdoor Power Box, 24VAC/144W, IP67, IK10	 AA-352 Outdoor Power Box, 24VAC/144W, IP67, IK10	 HLG-120H-24 Industrial 24VDC/120W Power Supply, IP67			
95W PoH/PoE					
 AW-IHH-0100 Industrial 1xGE 95W PoH/PoE Injector	+	 HLG-120H-54 Industrial 54VDC/120W Power Supply, IP67	 AW-IHH-0200 Industrial 1xGE 95W PoH/PoE + 1x SFP GE Switch	+	 HLG-120H-54 Industrial 54VDC/120W Power Supply, IP67

Compatible Accessories

PoE Kit/Power Adapter

95W PoH/PoE



AP-GIC-011A-095
1xGE 95W PoH/PoE Injector with Surge Protection 12KV



AP-GIC-015B-095
Outdoor 1xGE 95W PoH/PoE Injector with Surge Protection 12KV, IP67, IK10