



# RG-AP680-L

## Wi-Fi 6 Dual-Radio Access Point

# 01

## Product Overview

The RG-AP680-L is an 802.11ax-compliant dual-radio wireless access point (AP) provided by Ruijie Networks for general education, small- and medium-sized enterprise, energy, business, government, healthcare, and other outdoor scenarios.

It complies with 802.11ax, 802.11ac Wave2, 802.11ac Wave1, and 802.11n. With a hardware-independent dual-radio design, the RG-AP680-L can provide a data rate of up to 2.976 Gbps. The ultra-fast wireless rate eliminates the performance bottleneck.

The design of the RG-AP680-L considers factors such as wireless network security, radio control,

mobile access, QoS, seamless roaming. With Ruijie's access controller (AC) and Ruijie Cloud servers, the RG-AP680-L can implement wireless client data forwarding, security features, access control.

The RG-AP680-L adopts IP68 rated housing. It is applicable to harsh outdoor environments and easy to install and maintain.

The RG-AP680-L supports both local power supply and Power over Ethernet (PoE), so customers can flexibly select the power supply. It supports built-in smart antennas, to meet requirements of outdoor Wi-Fi coverage and outdoor networking in most environments.

# 02

## Product Appearance



Front View



Left Top View



Rear View

# 03

## Product Highlights

- Data rate of up to 2.976 Gbps and concurrent dual-radio design
- Up to 1024 client connections
- Built-in smart omnidirectional antenna
- Excellent environmental adaptability: IP68, -40°C to +65°C (-40°F to +149°F), and 9 kV surge protection
- OFDMA, MU-MIMO technologies for minimal wireless signal interference
- Hybrid management: support for thousands of standalone APs, and AC management and public cloud deployment options
- Mobile management: free mobile applications for Ruijie Cloud customers

# 04

## Product Features

### Multiple Service Ports

The RG-AP680-L supports dual uplink GE Ethernet ports: one GE Ethernet electrical port and one GE Ethernet optical port.

Both the auto-negotiation Ethernet electrical port and optical port provide a maximum data rate of 1 Gbps, guaranteeing high-speed transmission of service data between wireless and wired networks.



### High-speed Wireless Access for Better Experience

The RG-AP680-L optimizes user experience by maximizing Wi-Fi utilization and substantially reducing airtime competition between clients. It provides Orthogonal Frequency-Division Multiple Access (OFDMA) and Multi-User Multiple-Input Multiple-Output (MU-MIMO). With up to 2 spatial streams (2SS) and 160 MHz channel bandwidth (HE160), the RG-AP680-L delivers the data rate of up to 2.4 Gbps at 5 GHz band, providing pioneering wireless capabilities for enterprises.

#### 1024-QAM High-Speed Access

The RG-AP680-L adopts the dual-radio design and complies with the next-generation Wi-Fi standard IEEE 802.11ax. When dual radios are enabled, it can provide a wireless data rate of up to 2.976 Gbps to realize high-speed access experience.

#### OFDMA High-Density User Access

OFDMA enables the RG-AP680-L to divide a WLAN channel into multiple narrower sub-channels, with each user occupying one or more sub-channels. The RG-AP680-L can schedule services of multiple users, and receive and send packets concurrently. This reduces contention for air interface resources and backoff, shortens the network latency, and improves the network efficiency.

### MU-MIMO

The RG-AP680-L maximizes the use of MU-MIMO, which can effectively improve the throughput of a wireless network by exchanging data with multiple single-stream or dual-stream client devices simultaneously.

### Seamless Switching

The RG-AP680-L supports Hotspot 2.0 of Wi-Fi Association (WFA) and automatic identity recognition, providing clients with seamless cellular-to-Wi-Fi switching.

### Diverse Wi-Fi Technologies

It supports RF transmission technologies:

- Dynamic frequency selection (DFS) optimizes the use of available RF spectrum to prevent radar channel interference.
- Cyclic delay/shift Diversity (CDD/CSD) improves downlink RF performance, and converts spatial diversity to frequency diversity to avoid intersymbol interference, thus reducing bit error rate (BER) and effectively reducing signal distortion.
- Maximum ratio combining (MRC) improves the signal quality at the receiving end and enhances reliability and performance of received signals.

It supports RF channel coding technologies:

- Space-time block coding (STBC) increases the range and improves signal receiving, and enhances reliability of data transmission.
- Low-density parity check (LDPC) corrects errors efficiently and improves the throughput.
- Transmit beam-forming (TxBF) expands the signal coverage and enhances the reliability of specific devices, thereby improving the data rate.

### Intelligent Optimization, Reliability Guarantee

#### Intelligent Recognition, One-Click Network Optimization

The RG-AP680-L can intelligently identify mobile clients such as iOS and Android clients and PCs.

It can be used to implement visualized wireless network management based on the wireless client type and optimize a network in one-click mode.

The RG-AP680-L embeds client experience measurement and environment collection capability. It can be used with the RG-WS wireless access controller for intelligent analysis and automatic RF resource scheduling. It can adjust the RF power and intelligently allocate channels to solve problems such as co-channel interference, adjacent channel interference, and roaming stickiness.

### Intelligent Local Forwarding

The RG-AP680-L integrates intelligent local forwarding technology and eliminates the traffic bottleneck on its connected wireless access controller. The data forwarding mode of the RG-AP680-L can be flexibly pre-configured through Ruijie's wireless access controller. Then the RG-AP680-L determines whether data needs to be forwarded by the AC or be sent to a wired network for data exchange based on the SSID or user VLAN.

With the local forwarding technology, the RG-AP680-L classifies the data that is sensitive to the delay and requires real-time high-performance transmission, and forwards it through a wired network. This greatly relieves the traffic burden of the wireless access controller and better adapts to heavy-traffic transmission on 802.11ax networks.

### Client Access Optimization

The RG-AP680-L can dynamically measure parameters such as the uplink Received Signal Strength Indicator (RSSI), noise floor, and channel utilization to intelligently identify the client network status. Moreover, it can steer clients to preferentially connect to 5 GHz or APs with better experience. This solves the problems of roaming stickiness, remote association, and load imbalance, and improves user experience.

### Advanced Network Coexistence

The RG-AP680-L supports advanced network coexistence. It uses the built-in filter to automatically minimize the impact of interference from non-Wi-Fi network devices.

### Abundant QoS Policies

The RG-AP680-L provides abundant QoS policies. It supports bandwidth limiting based on the WLAN, AP, and STA, and provides Wi-Fi Multimedia (WMM) that

defines priorities for different service data. Therefore, it implements immediate and quantitative transmission of audio and video data, and guarantees smooth application of multimedia services.

The multicast-to-unicast technology supported by the RG-AP680-L solves the video freezing problem caused by packet loss or long latency in Video on Demand (VoD) and other multicast applications on a wireless network. It enhances the experience in the use of multicast video services on a wireless network.

### Green Design and Low Power Consumption

The RG-AP680-L incorporates packet-based power control technology. With high-performance power design, the RG-AP680-L is energy-efficient while providing high-speed wireless access services.

### Rich IoT Platform Features

The RG-AP680-L integrates Bluetooth 5.0 and 802.15.4 RF (ZigBee support) to simplify deployment and management of IoT-based location services, asset tracking services, security solutions, and IoT sensors. It allows access through Bluetooth serial ports.

### Comprehensive Security Protection and Ease of Use

#### Comprehensive Wireless Security Protection

The RG-AP680-L supports WEP (64/128 bits), WPA-TKIP, WPA-PSK, WPA2-AES, WPA3 authentication and encryption methods, and PPSK and UPSK technologies. Only the AC is needed to provide security for user data without the need for an authentication server.

It supports the following WPA3 types: WPA3-Personal (SAE), WPA3-Personal mixed mode, and WPA3-Enterprise (CCMP, 128 bits).

The RG-AP680-L used with the RG-WS series wireless access controller can provide a series of wireless security protection functions such as Wireless Intrusion Detection System (WIDS), radio interference tracking, rogue AP containment, anti-ARP spoofing, and DHCP protection, to build a secure and reliable wireless network.

#### Multiple Easy-to-Use Authentication Modes

Together with Ruijie authentication system or multi-service AC, the RG-AP680-L supports a variety of efficient and easy authentication modes such as web, 802.1X, MSCHAPv2, MAC address bypass (MAB), SMS, and QR

code-based guest authentication. It conforms to the principle of authentication security upon network access.

MAB authentication frees the client from entering the username and password repeatedly. The username and password are required only upon the first login.

When a guest accesses a wireless network through SMS authentication, an authentication page pops up. On the authentication page, a guest can register an account using the mobile number, and accesses the Internet using the username and password in the SMS received.

QR code-based authentication is easy for guests to access the Internet. After accessing a wireless network, guests can receive a QR code prompt. They can access the network after being authorized by the visited employee, providing better security.

## Flexible Device Management Modes

### Flexible Switching Between Fat, Fit, and Cloud Modes

The RG-AP680-L supports flexible switchover among Fat, Fit, and cloud deployment modes.

When the RG-AP680-L is deployed in Fat and cloud mode, it can operate as a single device and be

managed by the local access controller (AC). It can also be connected to the Ruijie public cloud for cloud-based management. When the RG-AP680-L is deployed in Fit mode, it can be used with the AC to achieve more functions. In Fit mode, the RG-AP680-L can be deployed through Zero Touch Provisioning (ZTP). In addition, complete remote management also greatly enhances the O&M management efficiency of a wireless network.

### Bluetooth Serial Port for Easy Maintenance

The RG-AP680-L supports switching between Bluetooth serial port and iBeacon. If the Bluetooth serial port is used by default, a network administrator can manage the device through the mobile phone upon device faults, without onsite device maintenance.

### Mobile Monitoring and Optimization

You can use the free Ruijie Cloud App to achieve simple network management experience. This app features unified device lifecycle management, switches, and security gateways. The app also simplifies device configuration, monitoring, and optimization. For details, visit official website at <https://www.ruijienetworks.com/products/smb/cloud-service/cloud-service/ruijie-cloud-solution/mobile-app>.



## All-in-One for Small Branch Office

In small branch office scenarios, the RG-AP680-L serves as an AP to provide the wireless access service for the office area, and also functions as a VPN gateway. This all-in-one design simplifies network deployment and saves building costs.

### PPPoE

The RG-AP680-L can function as a PPPoE client and connects to the Internet through PPPoE. In this case, no gateway needs to be deployed in a branch office

area for Internet access.

### NAT

The RG-AP680-L supports the Network Address Translation (NAT) function to translate addresses between the LAN in the branch office and the Internet.

### IPsec VPN

The RG-AP680-L can establish IPsec VPN tunnels between the headquarters and branch offices to implement LAN interconnection.



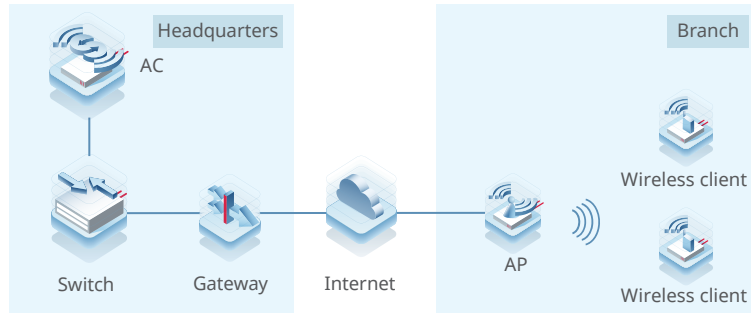

# 05 Specifications

## Hardware Specifications Dimensions and Weight

Dimensions and Weight	RG-AP680-L
Unit dimensions (W x D x H)	251 mm x 168 mm x 64 mm (9.88 in. x 6.61 in. x 2.52 in.)
Shipping dimensions (W x D x H)	405 mm x 232 mm x 325 mm (15.94 in. x 9.13 in. x 12.79 in.)
Unit weight	Main unit: 1.0 kg (2.20 lbs) Mounting bracket: 0.9 kg (1.98 lbs)
Shipping weight	3.15 kg (6.94 lbs)
Mounting	Ceiling/Pole-mount (a mounting bracket is delivered with the main unit)

## Wi-Fi Radio

Wi-Fi Radio	RG-AP680-L
Radio design	Dual-radio and four spatial streams: <ul style="list-style-type: none"> <li>Radio 1: 2.4 GHz, two spatial streams, 2x2 MU-MIMO</li> <li>Radio 2: 5 GHz, two spatial streams, 2x2 MU-MIMO</li> </ul>
Operating frequencies	Radio 1: 802.11b/g/n/ax <ul style="list-style-type: none"> <li>2.400 GHz to 2.483 GHz, channels 1 to 13</li> </ul> Radio 2: 802.11a/n/ac/ax <ul style="list-style-type: none"> <li>5.150 GHz to 5.250 GHz, U-NII-1, channels 36, 40, 44, and 48</li> <li>5.250 GHz to 5.350 GHz, U-NII-2A, channels 52, 56, 60, and 64</li> <li>5.470 GHz to 5.725 GHz, U-NII-2C, channels 100, 104, 108, 112, 116, 120, 124, 128, 132, 136, and 140</li> <li>5.725 GHz to 5.850 GHz, U-NII-3/ISM, channels 149, 153, 157, 161, and 165</li> </ul> Note: Country-specific restrictions apply.
Data rates	Combined peak data rate: 2.976 Gbps Radio 1: 2.4 GHz, 574 Mbps <ul style="list-style-type: none"> <li>Two spatial stream Single User (SU) MIMO for up to 574 Mbps wireless data rate to individual 2SS HE40 802.11ax client devices (max.)</li> <li>Two spatial stream Single User (SU) MIMO for up to 287 Mbps wireless data rate to individual 2SS HE20 802.11ax client devices (typical)</li> </ul> Radio 2: 5 GHz, 2.402 Gbps <ul style="list-style-type: none"> <li>Two spatial stream Single User (SU) MIMO for up to 2.402 Gbps wireless data rate to individual 2SS HE160 802.11ax client devices (max)</li> <li>Two spatial stream Single User (SU) MIMO for up to 1.201 Gbps wireless data rate to individual 2SS HE80 802.11ax client devices (typical)</li> <li>Two spatial stream Multi-User (MU) MIMO for up to 2.402 Gbps wireless data rate to up to two 1SS HE160 802.11ax DL-MU-MIMO capable client devices simultaneously (max)</li> <li>Two spatial stream Multi-User (MU) MIMO for up to 1.201 Gbps wireless data rate to up to two 1SS HE80 802.11ax DL-MU-MIMO capable client devices simultaneously (typical)</li> </ul>

Wi-Fi Radio	RG-AP680-L
Data rate set	The following 802.11-compliant data rates in Mbps are supported: 2.4 GHz radio <ul style="list-style-type: none"> <li>• 802.11b: 1, 2, 5.5, 11</li> <li>• 802.11g: 1, 2, 5.5, 6, 9, 11, 12, 18, 24, 36, 48, 54</li> <li>• 802.11n: 6.5 to 300 (MCS0 to MCS15, HT20 to HT40)</li> <li>• 802.11ac: 6.5 to 400 (MCS0 to MCS9, NSS = 1 to 2, VHT20 to VHT40)</li> <li>• 802.11ax: 8.6 to 575 (MCS0 to MCS11, NSS = 1 to 2, HE20 to HE40)</li> </ul> 5 GHz radio <ul style="list-style-type: none"> <li>• 802.11a: 6, 9, 12, 18, 24, 36, 48, 54</li> <li>• 802.11n: 6.5 to 300 (MCS0 to MCS15, HT20 to HT40)</li> <li>• 802.11ac: 6.5 to 1732 (MCS0 to MCS9, NSS = 1 to 2, VHT20 to VHT160)</li> <li>• 802.11ax: 8.6 to 2,402 (MCS0 to MCS11, NSS = 1 to 2, HE20 to HE160)</li> </ul>
Packet aggregation	802.11n/ac/ax : A-MPDU and A-MSDU
Antenna type	Built-in omnidirectional antenna (two 2.4 GHz antennas and two 5 GHz antennas)
Max. antenna gain	2.4 GHz radio: 4 dBi 5 GHz radio: 6 dBi
Max. transmit power	2.4 GHz radio: 28 dBm (25 dBm per chain) 5 GHz radio: 28 dBm (25 dBm per chain) Note: The transmit power is limited by local regulatory requirements.
Power increment	Configurable in increments of 1 dBm
Radio technologies	802.11b: Direct-Sequence Spread-Spectrum (DSSS) 802.11a/g/n/ac: Orthogonal Frequency-Division Multiplexing (OFDM) 802.11ax: Orthogonal Frequency Division Multiple Access (OFDMA)
Modulation types	802.11b: BPSK, QPSK, CCK 802.11a/g/n: BPSK, QPSK, 16-QAM, 64-QAM, 256-QAM 802.11ac: BPSK, QPSK, 16-QAM, 64-QAM, 256-QAM, 1024-QAM 802.11ax: BPSK, QPSK, 16-QAM, 64-QAM, 256-QAM, 1024-QAM

The following table lists the radio frequency performance of Wi-Fi including different frequency bands, protocols, and data rates. It is country-specific, and Ruijie Networks reserves the right of interpretation.

Wi-Fi Radio	RG-AP680-L		
Frequency Band and Protocol	Data Rate	Max. Transmit Power per Transmit Chain	Max. Receive Sensitivity per Receive Chain
2.4 GHz 802.11b	1 Mbps	25 dBm	-92 dBm
	2 Mbps	25 dBm	-82 dBm
	5.5 Mbps	25 dBm	-84 dBm
	11 Mbps	25 dBm	-78 dBm
2.4 GHz 802.11g	6 Mbps	25 dBm	-84 dBm
	24 Mbps	23 dBm	-74 dBm
	36 Mbps	23 dBm	-72 dBm
	54 Mbps	20 dBm	-67 dBm
2.4 GHz 802.11n (HT20)	MCS0	25 dBm	-84 dBm
	MCS7	20 dBm	-66 dBm
2.4 GHz 802.11n (HT40)	MCS0	25 dBm	-79 dBm
	MCS7	20 dBm	-63 dBm

Wi-Fi Radio	RG-AP680-L		
Frequency Band and Protocol	Data Rate	Max. Transmit Power per Transmit Chain	Max. Receive Sensitivity per Receive Chain
2.4 GHz 802.11ax (HE20)	MCS0	25 dBm	-84 dBm
	MCS11	18 dBm	-54 dBm
2.4 GHz 802.11ax (HE40)	MCS0	25 dBm	-80 dBm
	MCS11	18 dBm	-51 dBm
5 GHz 802.11a	6 Mbps	25 dBm	-84 dBm
	24 Mbps	23 dBm	-74 dBm
	36 Mbps	23 dBm	-72 dBm
	54 Mbps	20 dBm	-67 dBm
5 GHz 802.11n (HT20)	MCS0	25 dBm	-84 dBm
	MCS7	20 dBm	-66 dBm
5 GHz 802.11n (HT40)	MCS0	25 dBm	-81 dBm
	MCS7	20 dBm	-63 dBm
5 GHz 802.11ac (VHT20)	MCS0	25 dBm	-84 dBm
	MCS9	19 dBm	-61 dBm
5 GHz 802.11ac (VHT40)	MCS0	25 dBm	-81 dBm
	MCS9	19 dBm	-56 dBm
5 GHz 802.11ac (VHT80)	MCS0	25 dBm	-78 dBm
	MCS9	19 dBm	-53 dBm
5 GHz 802.11ax (HE20)	MCS0	25 dBm	-84 dBm
	MCS11	18 dBm	-54 dBm
5 GHz 802.11ax (HE40)	MCS0	25 dBm	-81 dBm
	MCS11	18 dBm	-51 dBm
5 GHz 802.11ax (HE80)	MCS0	25 dBm	-78 dBm
	MCS11	18 dBm	-48 dBm
5 GHz 802.11ax (HE160)	MCS0	25 dBm	-73 dBm
	MCS11	18 dBm	-43 dBm

## Bluetooth Radio

Bluetooth Radio	RG-AP680-L
Bluetooth	Bluetooth 5.0 iBeacon Bluetooth, applied to Bluetooth locating and Bluetooth applications
Antenna type	Integrated omnidirectional antenna



Bluetooth Radio	RG-AP680-L
Max. antenna gain	5 dBi
Max. transmit power	10 dBm
Receive sensitivity	-88 dBm (@BLE)

## Ports

Ports	RG-AP680-L
Fixed service port	1 x 10/100/1000Base-T Ethernet port with auto-negotiation, compliant-with IEEE 802.3af/802.3at standard 1 x GE SFP port
Fixed management port	1 x RJ45 console port (serial console port)
Status LED	1 x multi-color system status LED 3 x single-color RSSI LEDs
Button	1 x Reset button <ul style="list-style-type: none"> <li>• Press the button for shorter than 2 seconds. Then the device restarts.</li> <li>• Press the button for longer than 5 seconds. Then the device restores to factory settings.</li> </ul>

## Power Supply and Consumption

Power Supply and Consumption	RG-AP680-L
Input power supply	The AP supports the following two power supply modes: <ul style="list-style-type: none"> <li>• 48 V DC/0.35 A power input over DC connector: The DC connector accepts 2.0 mm/6.3 mm center-positive circular plug. A DC power adapter needs to be purchased independently.</li> <li>• PoE input over ETH/PoE: The power source equipment (PSE) complies with IEEE 802.3af/at standard (PoE/PoE+).</li> </ul> Note: <ul style="list-style-type: none"> <li>• If both DC power and PoE are available, DC power is preferred.</li> </ul>
Power consumption	Max power consumption: 12.95 W <ul style="list-style-type: none"> <li>• DC powered: 12.95 W</li> <li>• PoE powered (802.3af): 12.95 W</li> <li>• PoE+ powered (802.3at): 12.95 W</li> <li>• PoE++ powered (802.3bt): 12.95 W</li> <li>• Idle mode: 6.0 W</li> </ul>

## Environment and Reliability

Environment and Reliability	RG-AP680-L
Temperature	Operating temperature: -40°C to +65°C (-40°F to +149°F) Storage temperature: -40°C to +85°C (-40°F to +185°F) Note: At an altitude between 3,000 m (9,843 ft.) and 5,000 m (16,404 ft.), every time the altitude increases by 220 m (722 ft.), the maximum temperature decreases by 1°C (1.8°F).
Humidity	Operating humidity: 0% to 100% RH (non-condensing) Storage humidity: 0% to 100% RH (non-condensing)
IP rating	IP68
Mean Time Between Failure (MTBF)	> 250,000 hours

## Regulatory Compliance

Regulatory Compliance	RG-AP680-L
Regulatory compliance	EN 55032 EN 55035 EN 61000-3-3 EN IEC 61000-3-2 EN 301 489-1 EN 301 489-3 EN 301 489-17 EN 300 328 EN 301 893 EN 300 440 FCC Part 15 EN IEC 62311 IEC 62368-1 EN 62368-1

\*For more country-specific regulatory information and approvals, contact your local sales agency.

## Software Specifications

Applicable Software Version	RG-AP680-L
Applicable software version	RGOS11.9(6)W3B3 or later

## WLAN

WLAN	RG-AP680-L
Max. number of BSSIDs	32 (up to 16 BSSIDs per radio)
STA management	SSID hiding Each SSID can be configured with the authentication mode, encryption mechanism, and VLAN attributes independently. Remote intelligent perception technology (RIPT) Intelligent client identification technology Intelligent load balancing based on the STA quantity or traffic
STA limiting	SSID-based STA limiting Radio-based STA limiting
Bandwidth limiting	STA/SSID/AP-based rate limiting
Wireless roaming	Layer 2 and Layer 3 roaming

## Security

Security	RG-AP680-L
Authentication and encryption	Remote Authentication Dial-In User Service (RADIUS) PSK, web, 802.1x and MSCHAPv2 authentication QR code-based guest authentication (used with the RG-WS series wireless access controller) SMS authentication (used with the RG-WS series wireless access controller) MAB authentication (used with the RG-WS series wireless access controller) Data encryption: WPA-TKIP, WPA-PSK, WPA2-AES, WEP (64/128-bit)
Data frame filtering	Allowlist, static blocklist, and dynamic blocklist
WIDS	User isolation Rogue AP detection and containment
ACL	Dynamic ACL assignment

Security	RG-AP680-L
CPP	Supported
NFPP	Supported

### Routing and Switching

Routing and Switching	RG-AP680-L
IP service	Static IPv4 address and DHCP-assigned IPv4 address NAT, FTP ALG, DNS ALG
Multicast	Multicast-to-unicast conversion
IPv6 basics	IPv6 addressing, Neighbor Discovery (ND), ICMPv6, IPv6 ping IPv6 DHCP client
IP routing	IPv4/IPv6 static routing
VPN	PPPoE client IPsec VPN

### Management

Management	RG-AP680-L
Network management	Fault inspection and alarm Information statistics and logging
Network management platform	Web-based management (Eweb)
User access management	Telnet, SSH, SNMP , and TFTP-based management
Fat/Fit/Cloud mode switchover	When the AP works in Fit mode, it can be switched to Fat mode through an AC. When the AP works in Fat mode, it can be switched to Fit mode through the console port or Telnet. When the AP works in Cloud mode, it can be managed through Ruijie Cloud.

# 06

## Antenna Pattern Plots

### Horizontal Planes (Top View)

The following figures show the azimuth antenna pattern at 2.4 GHz and 5 GHz radios.

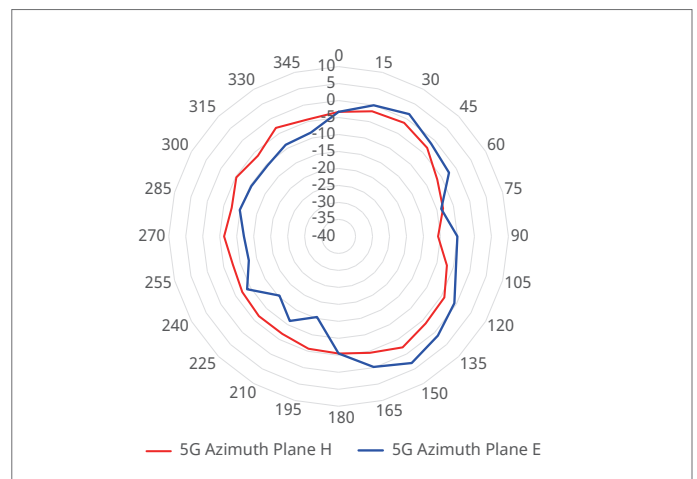
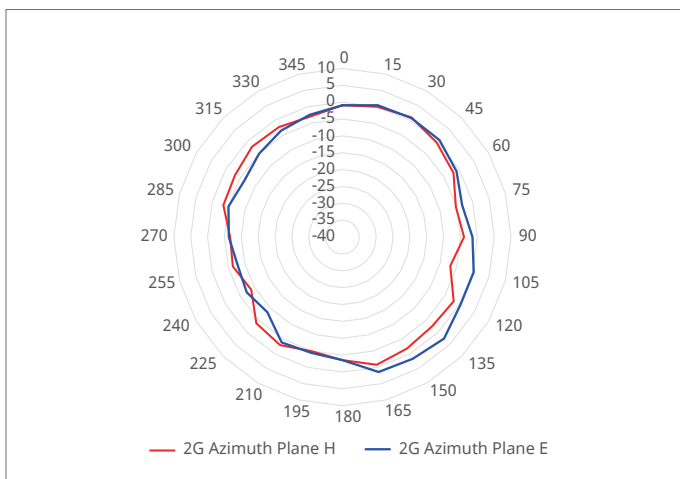

### Vertical Planes (Side View, AP Facing Down)

The following figures show the evaluation antenna pattern at 2.4 GHz and 5 GHz radios.

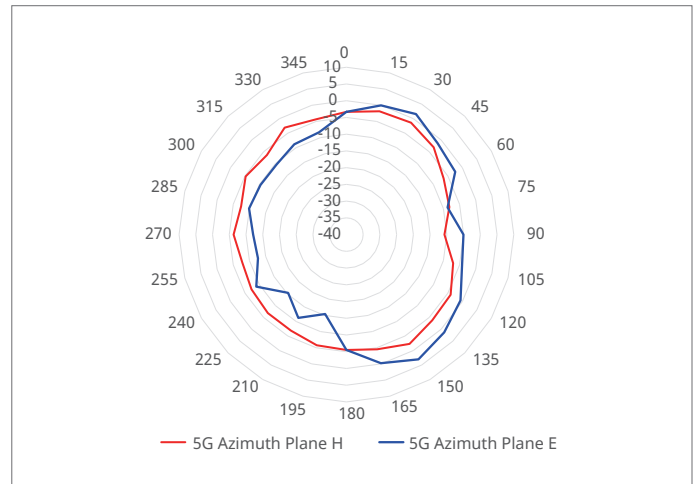
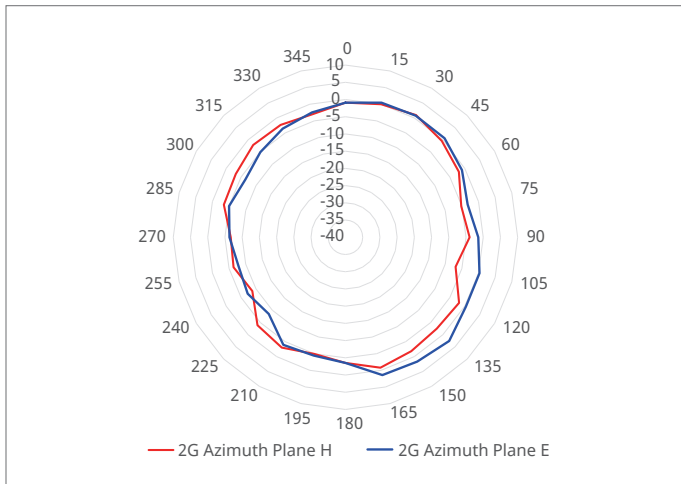

Note: Operating frequency bands are country-specific.

## 07 Typical Applications

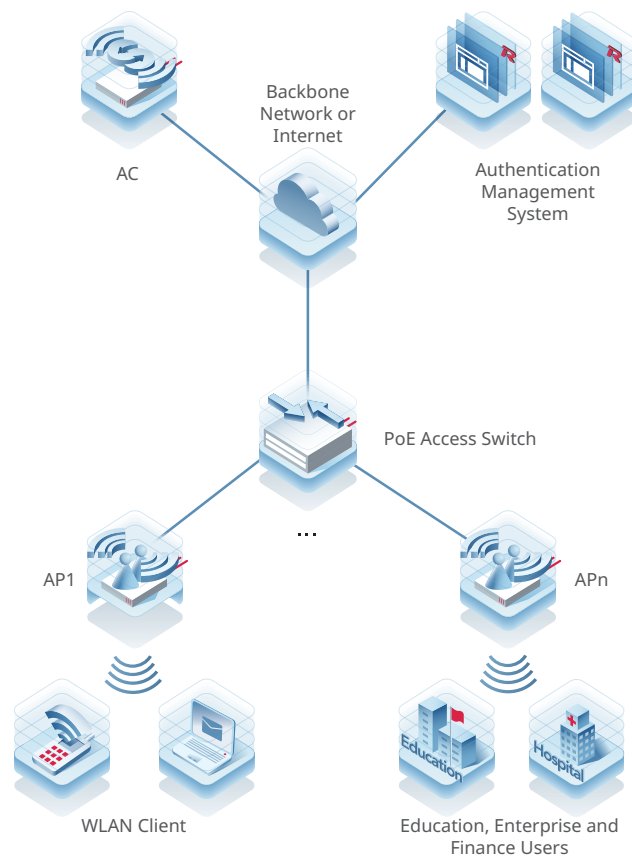

## Typical Scenario

The AP is applicable to densely populated areas with simple building structures, no special obstructions, and a large capacity demand. Such areas cover the scenarios of higher education, wireless city, energy, and plaza. The AP can be flexibly deployed based on the environment.

## Public Cloud Deployment

With Ruijie public cloud service, the RG-AP680-L is fit for SME scenarios, including small offices, boutique hotels, and retail stores. Ruijie Networks provides customers with Ruijie Cloud lifetime free licenses. It significantly streamlines the IT operational efficiency, and simplifies wireless deployment with cost-effective options for SMEs.

The Ruijie Cloud service provides network provisioning, monitoring, optimization, operation, and maintenance. Devices can be easily deployed or swapped in plug-and-play mode. Automatic RF planning meets the needs of increasing user experience.

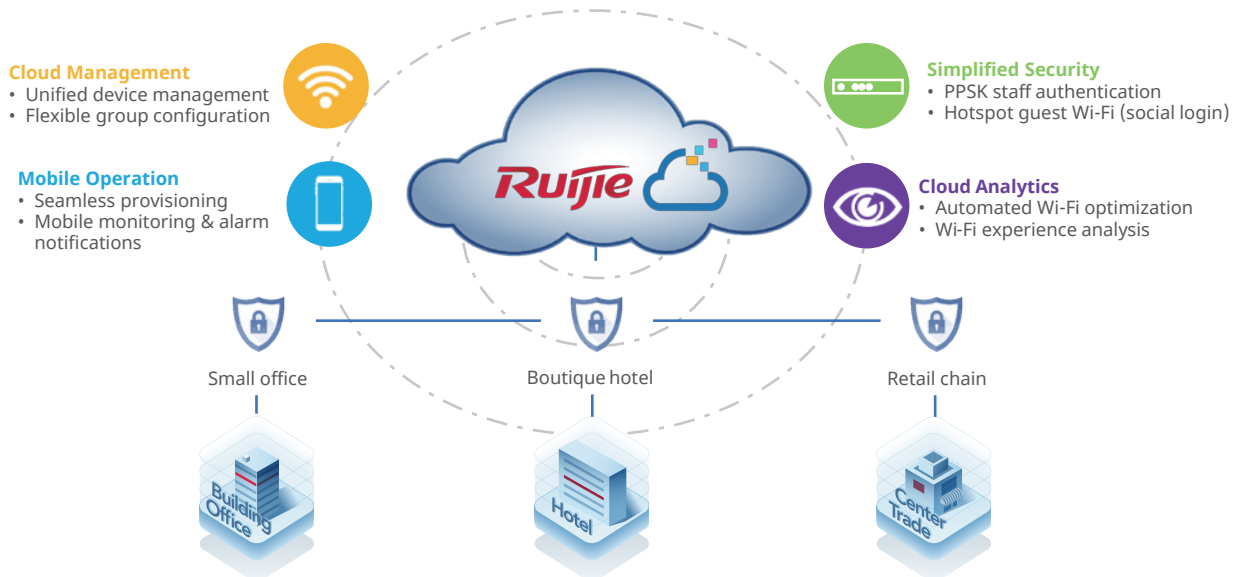

## Key Features:

- Unified device management
- Fast provisioning by Cloud and App
- Secure PPSK/UPSK authentication
- Captive portal & social media authentication
- App-based monitoring and alarm

## Hybrid Cloud Deployment

For enterprise office, campus network, and hospitality customers with single or multiple sites, a hybrid mode consisting of Ruijie RG-WS series wireless access controller (on-premises) and cloud-based management (optional) is recommended for high-density AP deployment. Wireless access controllers are installed at the customer's site with fully integrated wireless management and authentication features, supporting large-scale AP management with cluster-based controller architecture. Optionally, the cloud management platform allows for value-added features such as centralized device configuration and monitoring, and reporting.

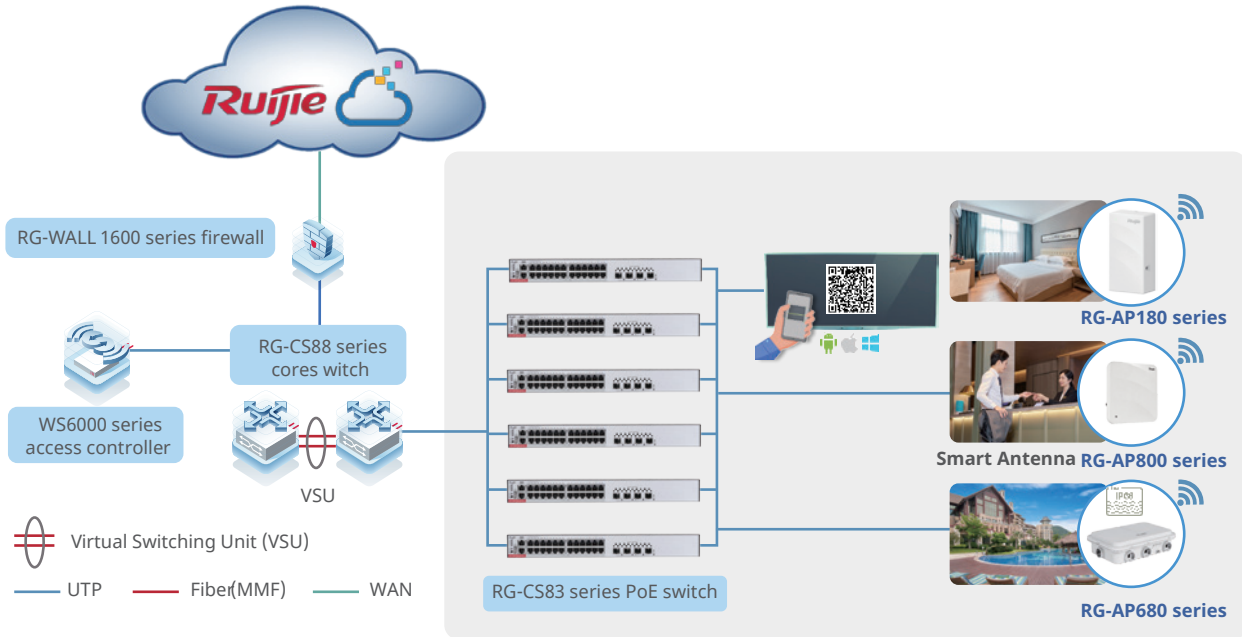

**Key Features:**

- Centralized device management and reporting by Ruijie Cloud
- Ultra-seamless roaming management
- High performance and security with all user authentication and traffic forwarding handled locally
- Flexible authentication options, including 802.1X, MSCHAPv2, PPSK/UPSK, and voucher authentication
- Unified management of all series of Ruijie APs

# 08

## Ordering Information

Model	Description
RG-AP680-L	Wi-Fi 6 dual-radio wireless access point Compliance with IEEE 802.11a/b/g/n/ac and 802.11ax standards Built-in omnidirectional antennas Up to four spatial streams Data rate of up to 2.975 Gbps Fat/Fit/Cloud mode switchover Electrical and optical uplink ports IEEE 802.3af/at-compliant (PoE/PoE+) power supply and DC power supply (48 V/0.35 A)



# 09

## Package Contents

Item	Quantity
Mounting plate assembly	1
Ceiling/Pole-mount bracket	1
M5 machine screw	4
M8 machine screw	2
M6 x 50 mm expansion anchor	4
Hose clamp	2
Watertight cable gland for the Ethernet cable power cord	2
Watertight cable gland for the optical cable	1
Dust cap	3
Grounding cable	1
Warranty Card	1

# 10

## Warranty

For more information about warranty terms and period, contact your local sales agency:

- Warranty terms: <https://www.ruijienetworks.com/support/servicepolicy>
- Warranty period: [https://www.ruijienetworks.com/support/service\\_41](https://www.ruijienetworks.com/support/service_41)

Note: The warranty terms are subject to the terms of different countries and distributors.

# 11

## More Information

For more information about Ruijie Networks, visit the official Ruijie website or contact your local sales agency:

- Ruijie Networks official website: <https://www.ruijienetworks.com/>
- Online support: <https://www.ruijienetworks.com/support>
- Hotline support: <https://www.ruijienetworks.com/support/hotline>
- Email support: [service\\_rj@ruijienetworks.com](mailto:service_rj@ruijienetworks.com)



**Copyright ©2000-2023 Ruijie Networks Co., Ltd. All rights reserved.**

No part of this document may be reproduced or transmitted in any form or any means without prior written consent of Ruijie Networks Co., Ltd.

**Notice**

This content is applicable only to regions outside the China mainland. Ruijie Networks Co., Ltd. reserves the right to interpret this content.

The information contained herein is subject to change without notice. Nothing herein should be construed as constituting an additional warranty. Ruijie Networks Co., Ltd. shall not be liable for technical or editorial errors or omissions contained herein.



Ruijie Networks Co., Ltd  
Website: <https://www.ruijienetworks.com>